

# EF UNIT

## ■ SWITCH BOARD

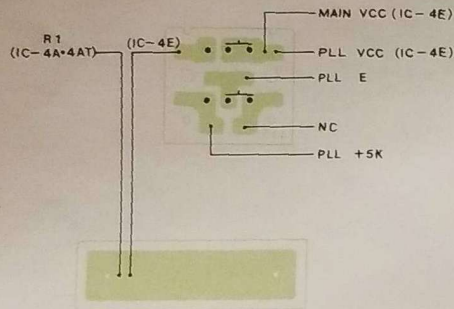

## ■ BATTERY CONTACT BOARD

## ■ VR BOARD

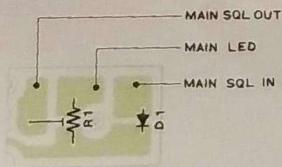

# FLEXIBLE UNIT

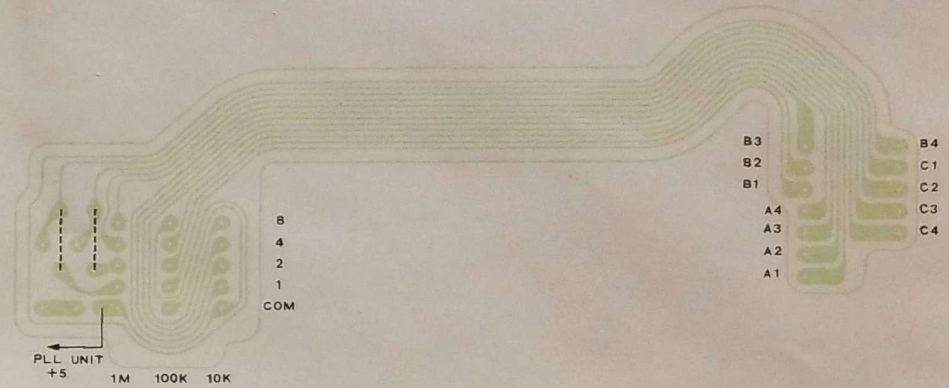

# KEY BOARD UNIT

## ■ IC-4AT ONLY

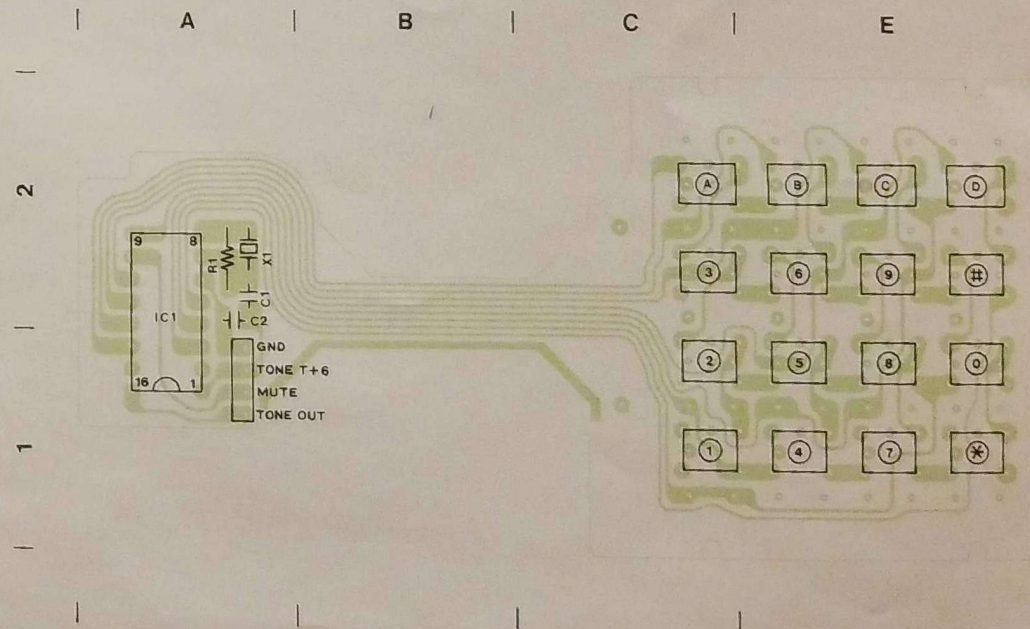

# BOARD LAYOUT

## PLL UNIT

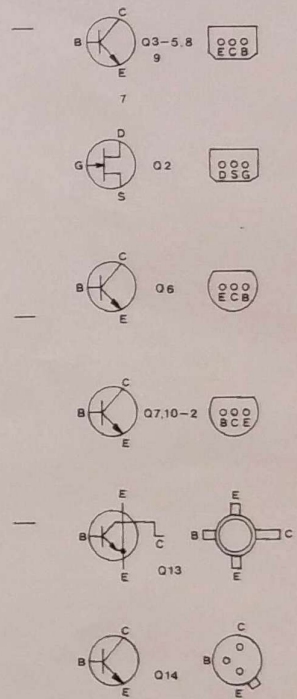
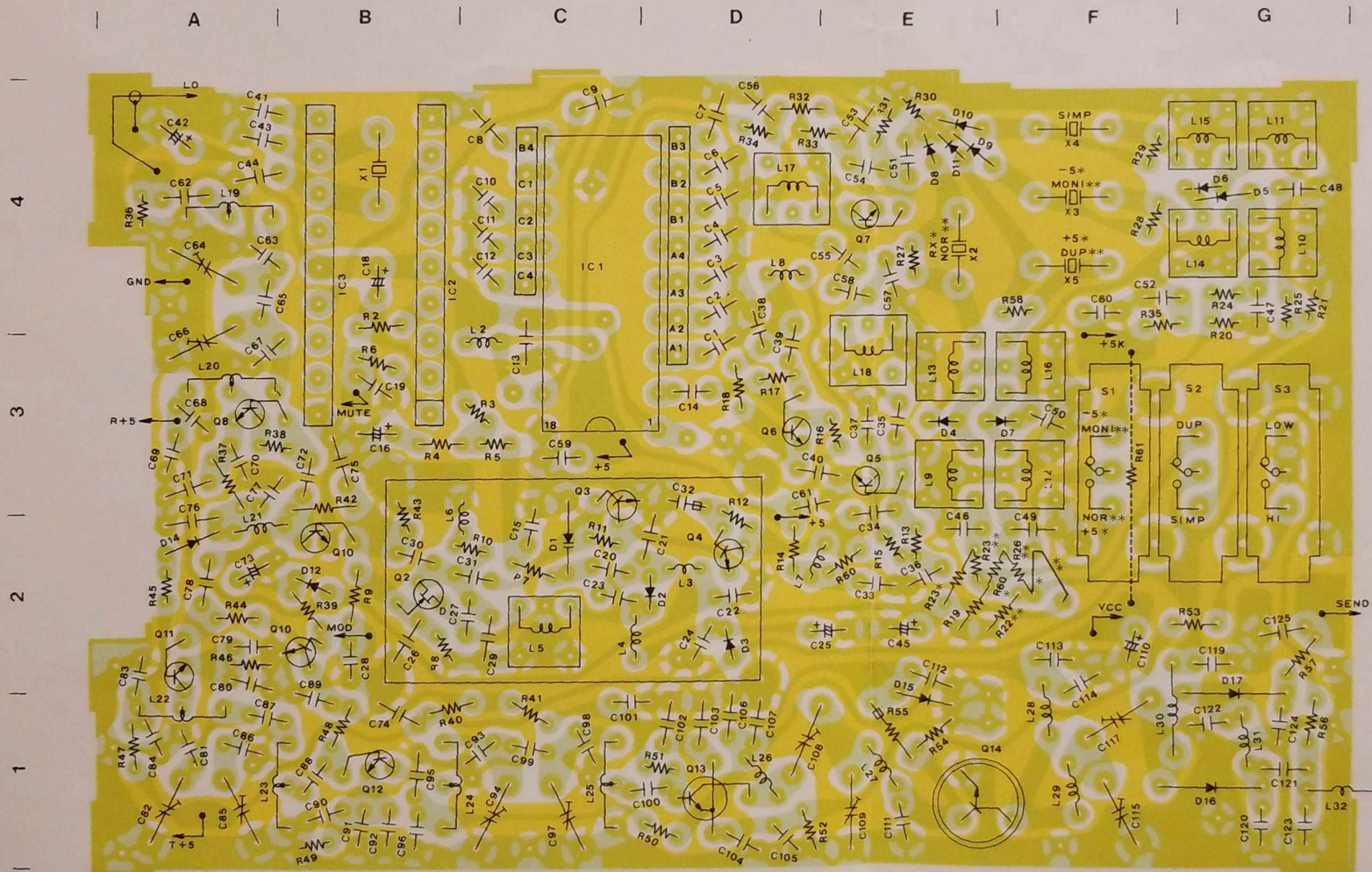

\*\* EUR ONLY  
 \* USA ONLY

## UNIT LAYOUT

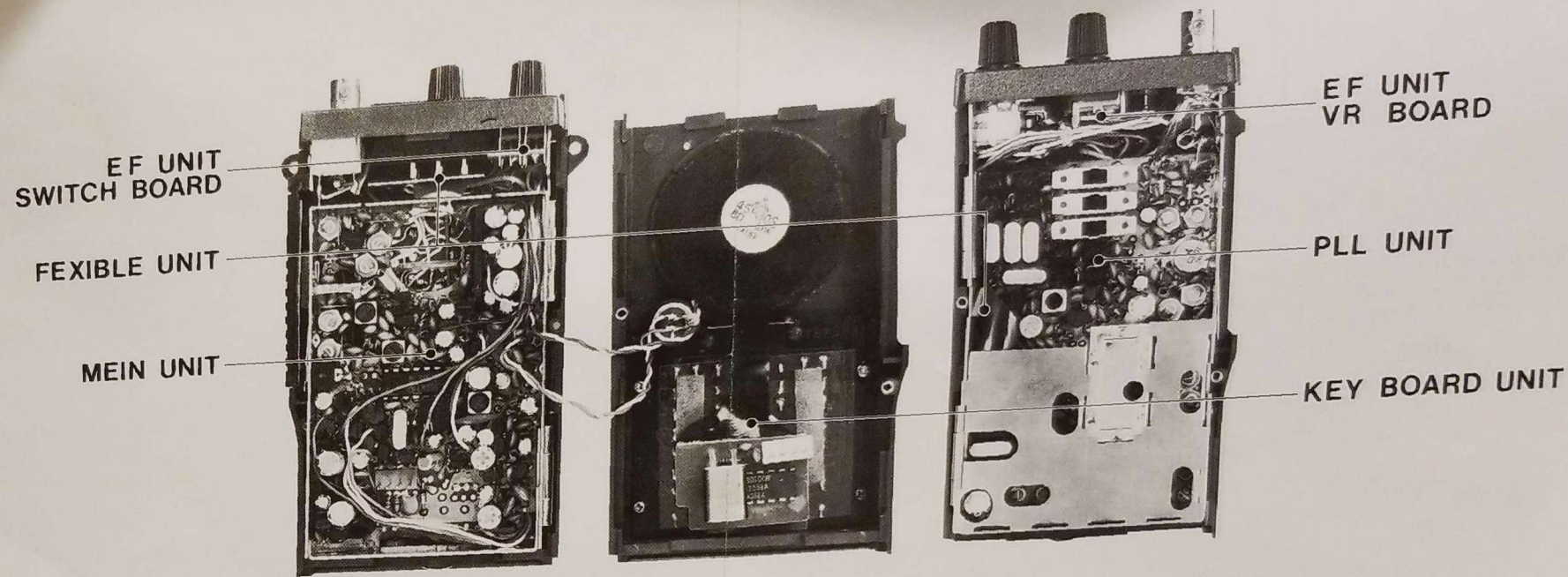

# ICOM INCORPORATED

Some components subject to change for  
an improvement without notice.

Printed in Japan



ICOM

# IC-4A-4E-4AT

# BOARD

## MAIN UNIT

4  
3  
2  
1

A B C D E F G

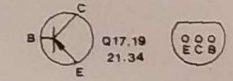
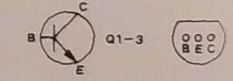
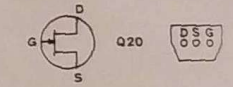
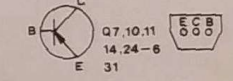
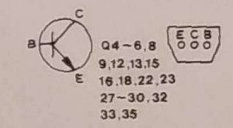
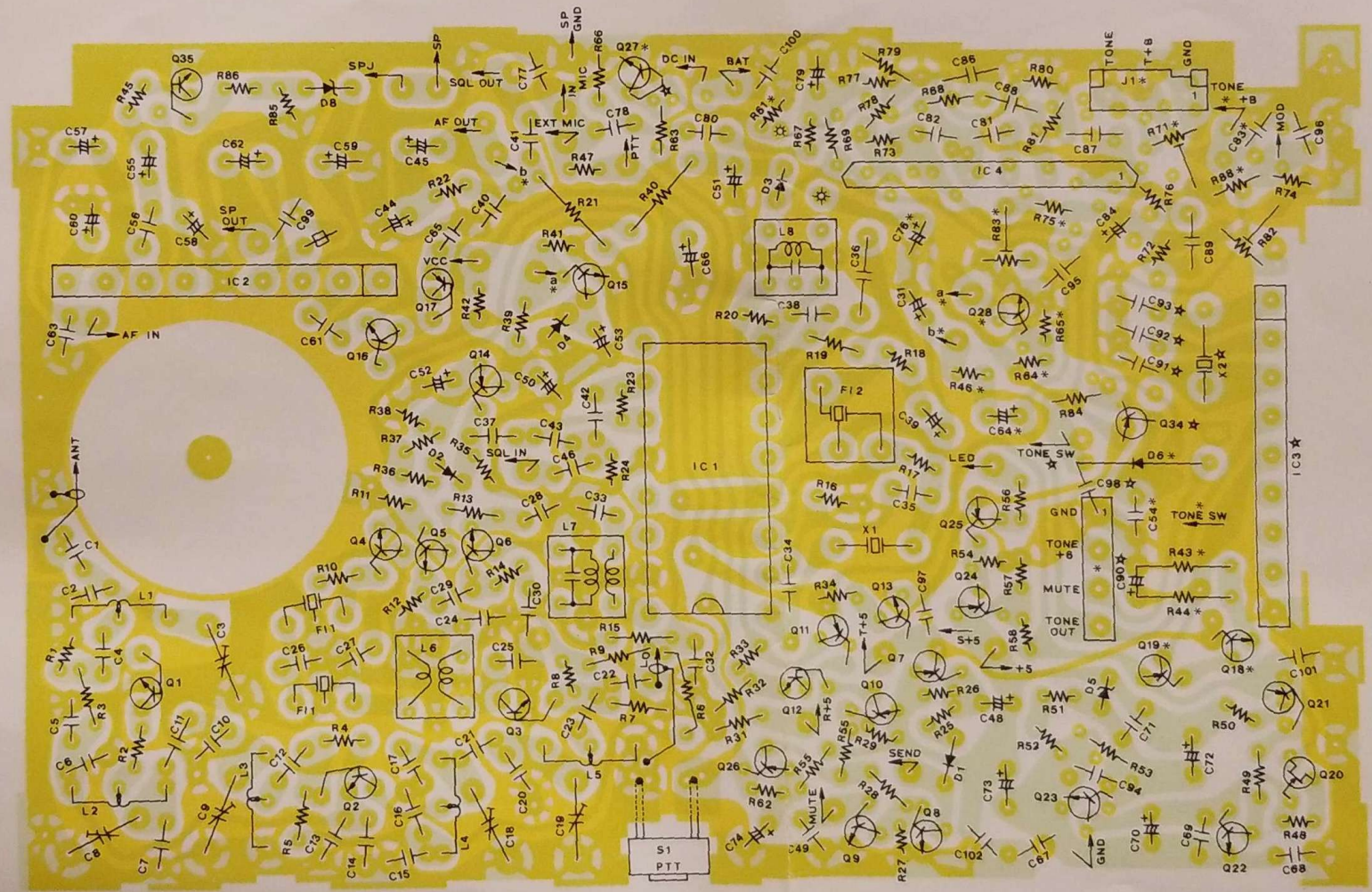

- ⚡ R59 4A, 4AT
- ⚡ D7 4E(DL), 4E(G), 4E(SM), 4E(I)
- ★ 4E(DL), 4E(G), 4E(SM), 4E(I)
- \* 4A, 4AT